



Veri-Phone™

Two-Way Voice Audio Verification Module

What is The Veri-Phone™ Audio Verification Module?

The Veri-Phone™ is a programmable two-way voice module that allows on-line communication between a central station and the premises. *Audio Verification* technology allows the central station to hear what is happening at the premises. *Two-Way Voice* further advances Audio Verification by giving the central station operator the capability to speak with a person on the premises. The alarm condition is verified by the central station operator without the need to call the premises and have a person answer the telephone, reducing the possibility of a false police dispatch.

The Veri-Phone™ may be programmed to allow your subscriber to call his premises using a TouchTone® phone to *Talk or Listen-In*, as a central station operator would. This feature cannot be used by your subscriber without entering their preprogrammed User Access Code.

How Can My Customer Benefit From Using the Veri-Phone™?

- **Reduction of False Alarms** - Subscriber error is the cause of over 75% of all false alarms. Two-Way Voice allows instant verification with the premises that will reduce false alarms.
- **Vital Information Can be Immediately Reported** - Knowing where someone is if trapped in a fire can make a life saving difference.
- **Powerful Deterrent** - Voice communication from central station to a burglar may be a better deterrent than a siren.
- **Special Functions** - Subscribers can call their premises, use their User Access Code, and Listen-in to all activity.
- **Speakerphone** - The Veri-Phone™ can be used as a speakerphone.

**For Technical Assistance, Contact the Napco Toll Free HelpLine: ☎
(800) 645-9440.**

Table of Contents

How Does the Veri-Phone™ Work? 4

Veri-Phone™ Features 4

Installation & Wiring 5

1. Mounting the Veri-Phone™ 5

2. Status Led 5

3. Select the Method of Veri-Phone™ Activation 5

 3.1 Trigger Method 6

 3.2 Fast Trigger Method 7

 3.3 Auto-Sense Method 8

4. Select the Method of Siren Silencing 9

 4.1 Veri-Phone™ Siren Silencing Relay 9

 4.2 MA1008e and MA1016e Siren Silencing 9

5. Speakers, Microphones and Speakermics 10

 5.1 Speakers 10

 5.2 Microphones 10

 5.3 Speakermics 11

 5.4 Microphone and Speaker Selection 12

 5.5 Microphone and Speaker Placement 12

 5.6 Microphone and Speaker Gain Adjustments 12

6. Testing 13

 6.1 VOX Talk/Listen Switching 13

 6.2 VOX Talk/Listen Switching Test 13

 6.3 Immediate Connect 13

 6.4 Automatic Callback Connect 13

7. Additional Wiring Options 14

 7.1 Inhibit Control (Terminal 11) 14

 7.1.1 Inhibit By Alarm 14

 7.1.2 Speakerphone Operation 14

 7.2 Listen Only Control (Terminal 12) 14

 7.2.1 Listen Only Control 14

 7.2.2 Privacy 14

 7.3 Control Output (Terminal 15) 14

 7.4 Inhibit Output (Module Active Output) (Terminal 16) 14

 7.5 Auto-Sense (Terminals 24, 25) 14

 7.5.1 Alarm Priority Auto-Sense 14

 7.5.2 Voice Priority Auto-Sense 14

VERI-PHONE™ AUDIO VERIFICATION MODULE

8. Additional Features and Options	15
8.1 Auto-Scan	15
8.2 User Call-In Mode	15
8.3 Operator Access Code	15
8.4 Exclusive Microphone Selection	15
Programming the Veri-Phone™	16
9. Dealer Programming	16
Power-Up Programming	16
Remote Programming	16
Hardware Configuration Information	17
Operator Information	18
User Information	19
Dealer Programming Sheet 1	20
Dealer Programming Sheet 2	21
10. User Programming	22
Local Programming	22
Remote Programming	22
11. Control of the Veri-Phone™ Using a TouchTone® Phone	23
11.1 Selecting the Standard or SIA Command Set	23
11.2 OPERATION using the Standard Command Set	23
11.3 OPERATION using the SIA Command Set	25
12. User Call-in; Gaining Access	27
13. Central Station Operation and Requirements	27
13.1 Central Station Requirements	27
13.2 Central Station Operation	27
13.3 CSAVM Operation (Central Station CSAVM Required)	28
13.3.1 Immediate Connect Method	28
13.3.2 Automatic Callback Connect	28
13.4 NON-CSAVM Operation (No CSAVM Required)	28
13.4.1 Immediate Connect Method	29
13.4.2 Automatic Callback Connect	29
Troubleshooting	30
Specifications	31
Ordering Information	31
Veri-Phone™ to Napco Control Panel Wiring Table	31
Veri-Phone™ Terminal Strip Connections	31
Glossary	32
INDEX	34

VERI-PHONE™ AUDIO VERIFICATION MODULE

How Does the Veri-Phone™ Work?

The Veri-Phone™ is preprogrammed to operate in an **Immediate Connect Mode**. Most installations will not require changes to the existing default program.

Immediate Connect Operation After an alarm condition is activated by the control panel and after the communicator has completed its call to the central station, the Veri-Phone™ seizes the telephone line before the connection is lost. The Veri-Phone™ then establishes two-way voice communication with the operator. The Veri-Phone™ will cut the siren during voice communication and turn the siren back on when the central station terminates the call (the control panel siren power must be wired through the siren cutoff relay of the Veri-Phone™). Refer to Figure 4 for other siren silencing options. An additional option is provided that will prevent the operator from ever switching to either *Talk* or *VOX* modes; refer to Installation & Wiring Section 7.2.1: Listen Only Control. If a CSAVM is used, and the central station does not pickup the call the Veri-Phone™ will disconnect and go into a *One-Ring Ten-Minute Callback Mode*. This gives the central station the opportunity to call back the premises within ten minutes and have the Veri-Phone™ pickup the line on the first ring and establish two-way voice communication with the operator. An Operator Access Code is programmable to further secure Veri-Phone™ communications.

Automatic Callback Connect Operation After an alarm condition is activated by the control panel and after the communicator has completed its call to central station, the Veri-Phone™ goes into a *One-Ring Ten-Minute Callback Mode*. This means that the Veri-Phone™ will allow the central station ten minutes to call back and will answer the call on the first ring. An Operator Access Code is programmable to further secure Veri-Phone™ communications. Once communication is established, operation is identical to the Immediate Connect method.

User Call-in Feature This programmable feature allows the customer to call his premises and establish two-way voice communication with the occupants. The user will dial his home phone number enter his user access code and the Veri-Phone™ will initiate an audio session. They will then have access to TouchTone commands that will allow them to listen and/or talk to the occupants. The subscriber can use this feature to check on the children, babysitter, elderly persons, etc., when away from home. When using this feature, it is recommended that the caller/listener obtain any required advance consent of the occupants of the premises prior to this procedure.

Veri-Phone™ Features

- Works with any Napco, and most other 12 Vdc Control Panels
- One-Ring Ten Minute Callback by Central Station After Alarm
- Works with any central station
- Three selectable microphone inputs, with auto-scan feature
- Speaker(s) can be mounted up to 500' away
- Programmable User, Dealer and Operator Codes
- Warning tones priors to timeout
- Use speakers as speakermics or separate microphones
- Trigger Input and Inhibit Control Input
- Status indicator LED
- Call-in to premises with a programmable Number of Rings
- Random Accounts (special audio verification account numbers not required when CSAVM is used)
- Listen Only control input.
- Siren Silence Relay
- Talk/Listen under central station control
- Call duration under central station control
- Module Active Output (for custom applications)
- Speakerphone Operation
- Privacy Feature

VERI-PHONE™ AUDIO VERIFICATION MODULE

Installation & Wiring

- Mounting the Veri-Phone™** The Veri-Phone™ is designed for mounting against any flat surface, including the rear bottom wall of the control panel enclosure. The unit may be attached using adhesive pads, Velcro® fasteners, or it may be secured with screws through the two oval mounting holes.
- Status Led** The red Status LED is a useful installation and troubleshooting tool, as it indicates the status of the Veri-Phone™. Use the Table below to determine the state of the Veri-Phone™.

Status LED	Mode	Mode during Audio Verification
Flashing on for two seconds and off for two seconds	Standby Mode	
Flickering rapidly	Ready Mode - A Control Panel is in digital communication with the central station receiver and the Veri-Phone™ is waiting for the panel to release the telephone line.	VOX Mode
Flashing on for one second and off for one second	10-Minute 1-Ring Callback Mode	
Flashes once every 5 seconds		Listen Mode
Steady Red	House phone is off hook	Talk Mode
On when phone is ringing, off during pause	Local phone is ringing	
Off longer than 10 seconds	Malfunction	

Table 1 Status LED Modes

- Select the Method of Veri-Phone™ Activation** There are two methods of activation: Trigger Method and Auto-Sense Method. The wiring of the Veri-Phone™ will depend upon the audio verification capabilities of the control panel used. Program the method of Veri-Phone™ Activation in Dealer Programming for either the Trigger or Auto-Sense Method. For either wiring option, use #22AWG to #18AWG stranded wire. Be sure not to run this wire near 120Vac wiring, or keypad wiring. **Note:** Either a telephone or a 1µF/250V non-polarized capacitor (for special applications) must be installed across Terminals 22 and 23 for Callback or Call-in Feature to function.

3. Select the Method of Veri-Phone™ Activation (Continued)

3.1 Trigger Method The Trigger Method (Trigger Input Terminal 13 or 14) is the preferred method of Veri-Phone™ activation. This method can be used with Napco Control Panels or any Control Panel that has an output that changes state upon digital communications and then returns to its normal state upon kissoff. Depending on the control panel in use, only one of these terminals will be needed. A transition from a high (12 Vdc) to a low (1 Vdc) will activate the Veri-Phone™ when connected to the TRIGL (Typical Napco Panel). A low-to-high transition will activate the Veri-Phone™ when connected to the TRIGH. Once activated, the LED will begin to flicker rapidly (*Ready Mode*). Finally, when the terminal is allowed to return to its normal state, the Veri-Phone™ will pick up the line and establish an audio session with the Central Station (Unless the Method of Connection is programmed for Automatic 10-Minute Callback, at which point it will go into the *One Ring Ten Minute Callback Mode*). Napco "e" series Control Panels are equipped with Lugs that can be programmed to allow audio verification upon alarm. The feature is programmable by zone which allows a more flexible selection of alarm conditions that the Veri-Phone™ will respond to. For example, the Lug may be programmed for Zones 1 - 4 but not for an AC Failure or Low Battery condition. The Veri-Phone™ will not be activated for those zones or conditions unless the Audio Verification Lug is programmed to do so. Program the method of Veri-Phone™ Activation for *Activate with Trigger Method* in Dealer Programming. If Voice Priority is required wire the trigger input through the COMM and the N/C contacts of a NAPCO RB1000 relay. Refer to Note 2.

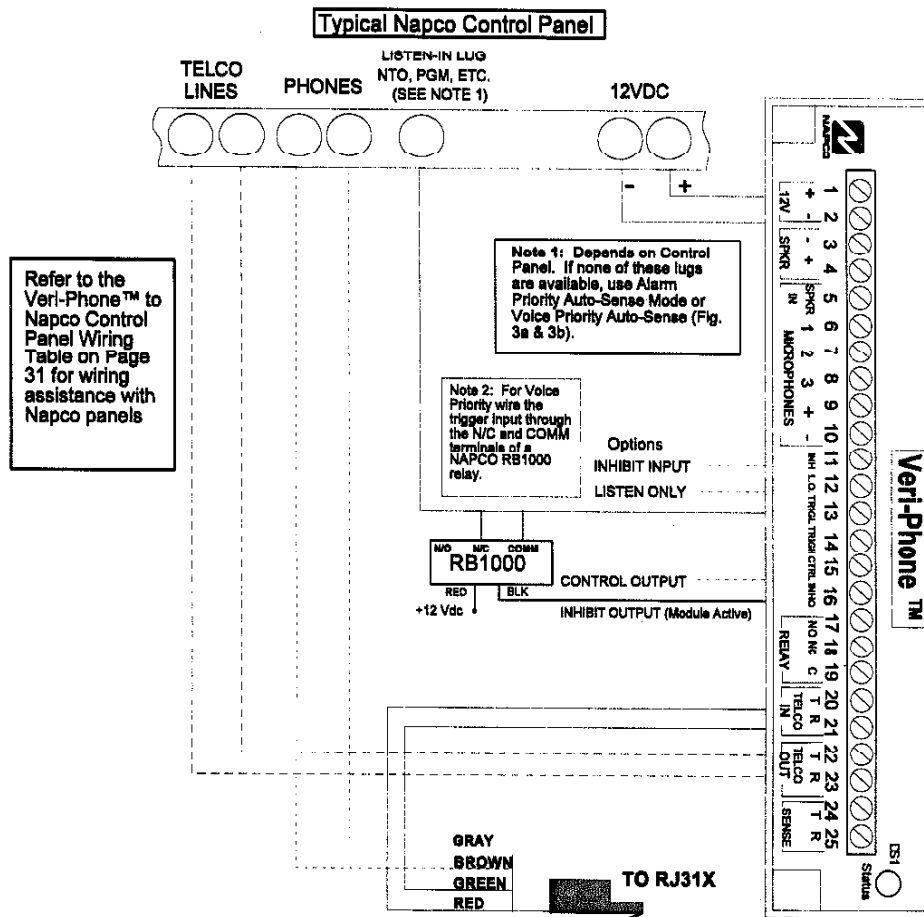

Figure 1 Trigger Method of Telephone Wiring

VERI-PHONE™ AUDIO VERIFICATION MODULE

3. Select the Method of Veri-Phone™ Activation (Continued)

3.2 Fast Trigger Method For control panels that provide a momentary trigger, wire as shown in figure 2. Select *Fast Trigger* in Dealer Programming. Program the method of Veri-Phone™ Activation for *Activate with Trigger Method* in Dealer Programming. If Voice Priority is required wire the trigger input through the COMM and the N/C contacts of a NAPCO RB1000 relay. Refer to Note 2.

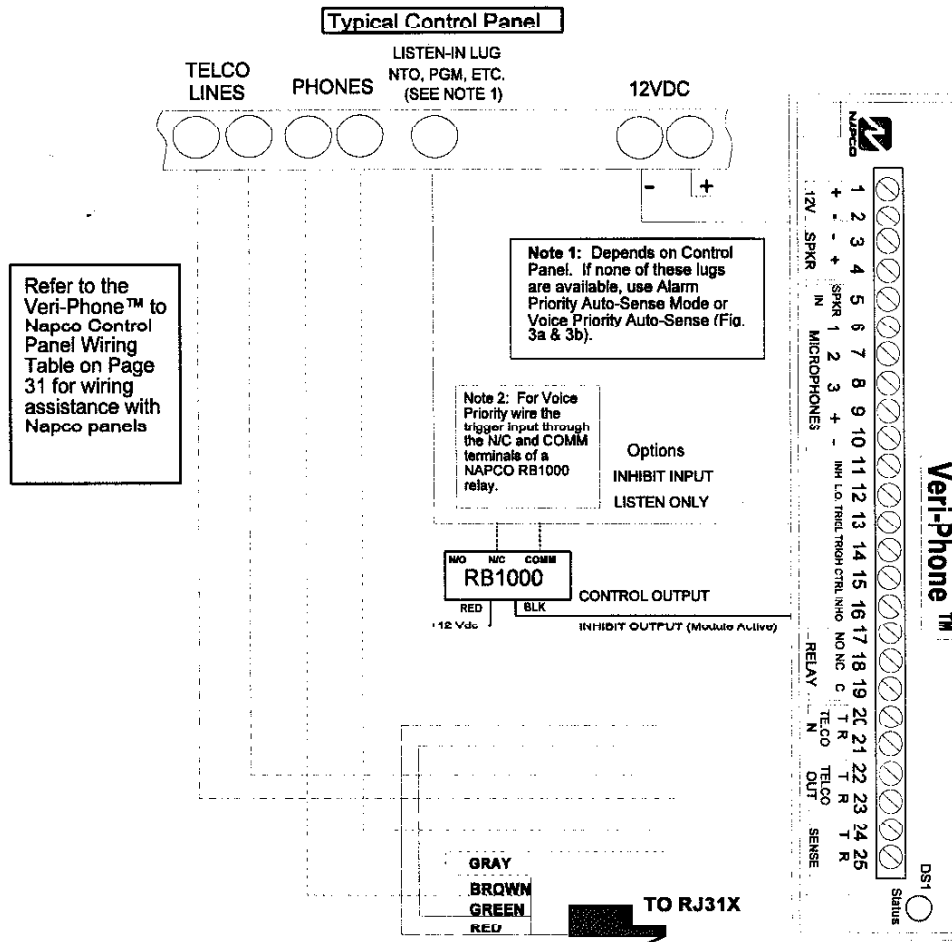

Figure 2 Fast Trigger Method of Telephone Wiring

3. Select the Method of Veri-Phone™ Activation (Continued)

3.3 Auto-Sense Method The Auto-Sense method is recommended when not using a Napco control panel or any control panel that does not have an output that changes state during digital communications and then returns to its normal state upon kissoff. The Veri-Phone™ will be able to sense central station communication without the requirement of a trigger input. If Alarm Priority is required wire as shown in figure 3a. If Voice Priority is required wire as shown in figure 3b. **Note:** For Voice priority wiring it is recommended that the Method of Connection be programmed for Automatic 10-Minute Callback, since any failure to report the digital signal on the first attempt (no dial tone, busy signal, etc.) may result in a delay of subsequent attempts if used with the immediate connect method. Program the Method of Veri-Phone™ Activation for *Activate with Sense Method* in Dealer Programming. Refer to section 7.5 for more information on the Auto-Sense Method.

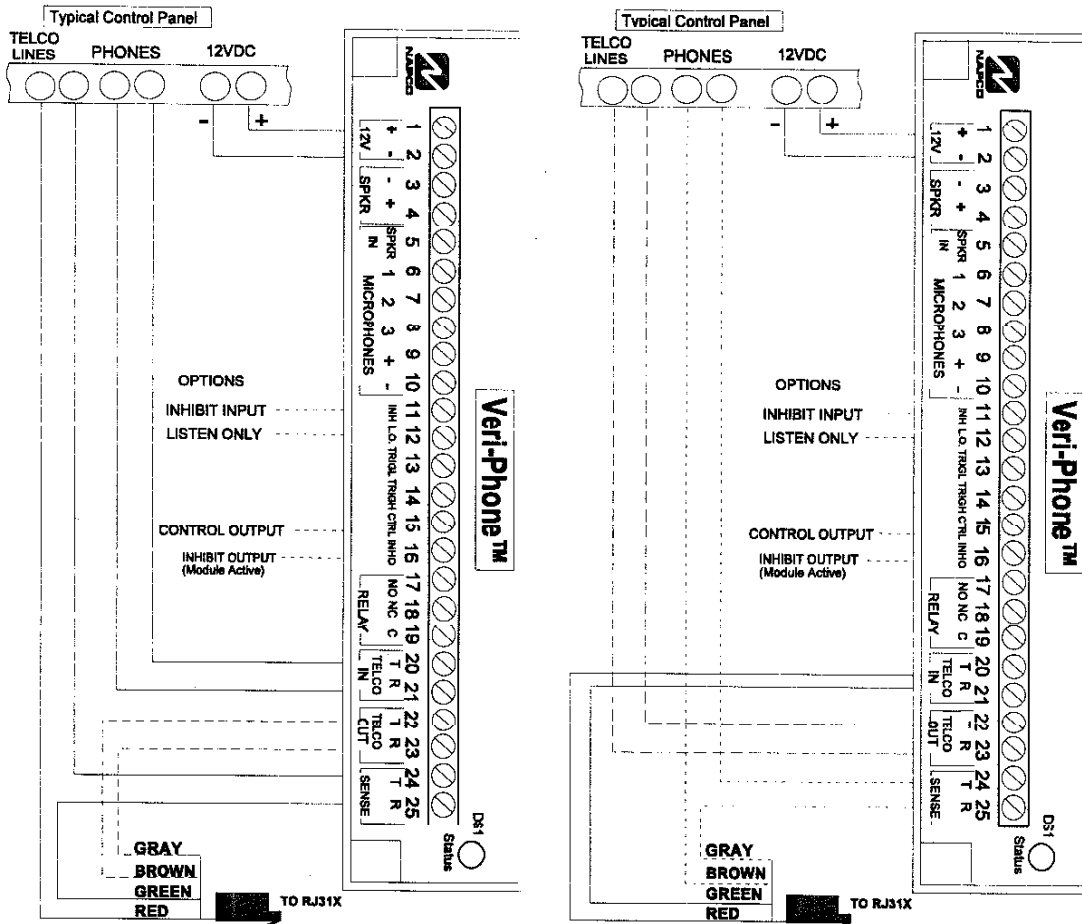

Figure 3a Alarm Priority Auto-Sense Telephone Wiring

Figure 3b Voice Priority Auto-Sense Telephone Wiring

4. Select the Method of Siren Silencing

- 4.1 **Veri-Phone™ Siren Silencing Relay** Wire the control panel siren power through the common (Terminal 19) and normally closed contact (Terminal 18) of the Veri-Phone™ Siren Silencing Relay. This will allow the Veri-Phone™ to turn off the siren during voice communications and turn it back on as soon as the central station disconnects. Refer to Figure 4a and 4b.
- 4.2 **MA1008e and MA1016e Siren Silencing** When using a MA1008e Napco Control Panel, connect the INHO (Terminal 16) output of the Veri-Phone™ to Zone 6. When using a MA1016e Napco Control Panel, connect the INHO output to Zone 12. The INHO output will go low during the audio session and cause the MA1008e or MA1016e to silence the keypad and siren. Refer to MA1008e or MA1016e documentation for programming instructions. Refer to Figure 4c.

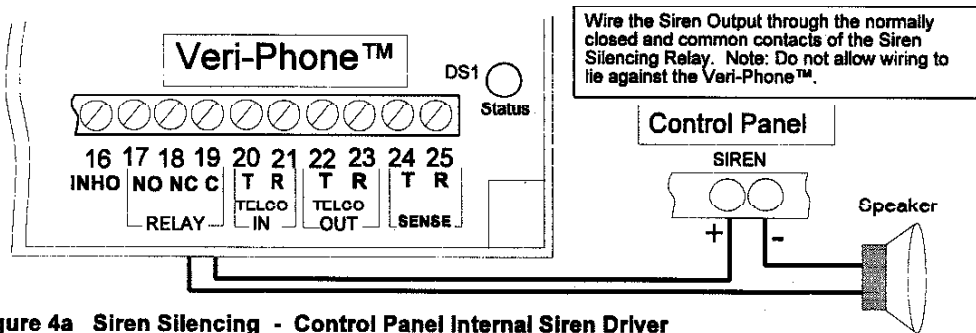

Figure 4a Siren Silencing - Control Panel Internal Siren Driver

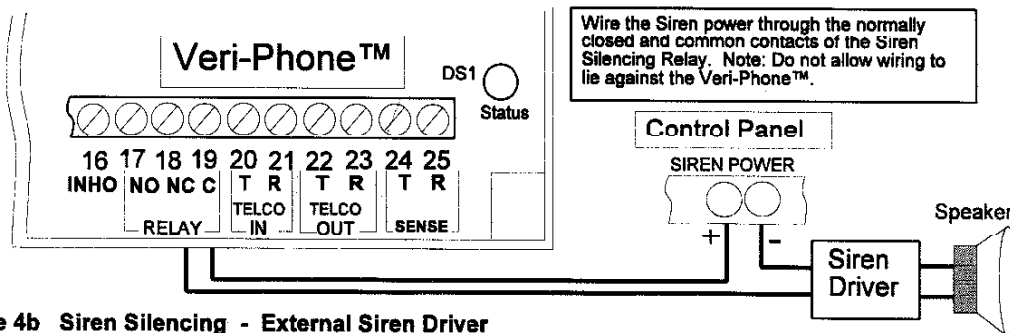

Figure 4b Siren Silencing - External Siren Driver

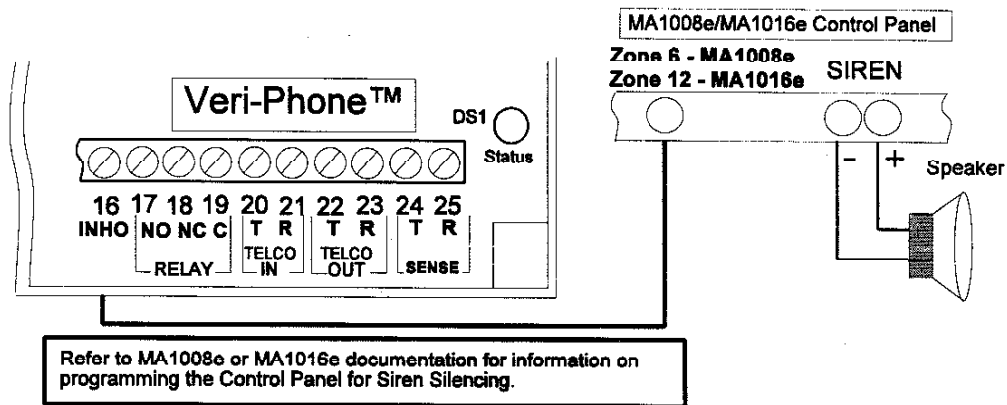

Figure 4c Siren Silencing - Ma1008e/MA1016e method

5. Speakers, Microphones and Speakermics

5.1 Speakers Connect Speaker(s) to terminals 3 and 4. (Polarity is not a factor.) When using ceiling speakers, install insulation behind the speaker to prevent unwanted noise from being heard from the second floor or roof. Speaker selection is very important, especially if the speaker is also being used as a microphone (speakermic). Paper-cone speakers work best, however plastic-cone speakers are more durable for outdoor applications. If more than one speaker is used, wire them in series-parallel to achieve an impedance of 4 ohms to 100 ohms (8 ohms is the typical value). Use 2 conductor #22AWG for wiring runs less than 100'. For wiring runs greater than 100' use twisted wire. Be sure not to run speaker wiring near 120Vac or high-voltage wiring.

5.2 Microphones Connect Microphone(s) to terminals 6, 7 and 8. The Veri-Phone™ can accept up to three separate microphones for sound pickup. If not using all three microphone inputs, short any unused microphone input(s) to Microphone 1 input. Connect power to terminal 9 and the shield to terminal 10. The microphones used with the Veri-Phone™ are powered microphones and require three wires: power, shield (ground), and signal. The microphone suitable for this purpose is Napco Part Number Mic-30. Do not exceed a 200' run from the microphone to the Veri-Phone™ and be sure to ground the shield only at Veri-Phone™ terminal 10. Two wire microphones can be used with the Veri-Phone™ as depicted in Figure 5, Microphone 3.

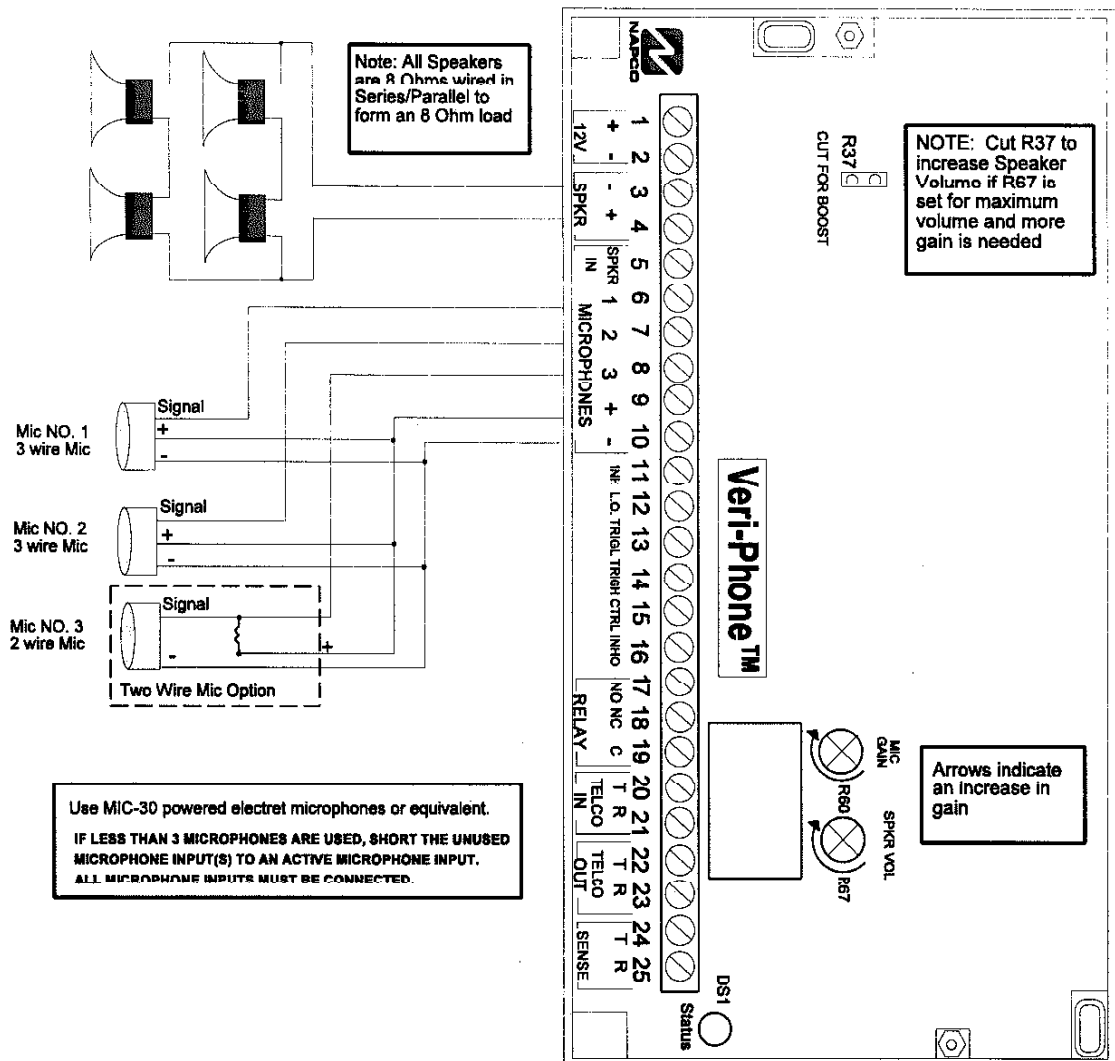

Figure 5 Selectable Microphones with Separate Speakers

5. Speakers, Microphones and Speakermics (Continued)

5.3 **Speakermics** Connect Speakermics to Terminal 3 and Terminal 4. A speaker used as a microphone (speakermic) is different from a microphone in that it detects sound from all directions (front and back) and can pick up vibrations in a wall (such as motors, etc.) that may otherwise not be audible. Terminals 7 and 8 may be used with a microphone, but if you are not using them, terminals 6, 7 and 8 must still be connected together. If selectable Speakermics are desired, it is recommended that multiple Speakermics be wired as shown in Figure 6a. With this configuration, each speakermic is individually selectable. This will allow the operator to select Speakermics using TouchTone commands. Figure 6b shows speakers operating as microphones where all microphones are listened to at the same time. If wired in this configuration, care should be exercised with more than one speakermic because the listen-in area is increased as well as the potential listen in noise. When wiring Speakermics to the Veri-Phone™, do not exceed a distance of 500'. Use shielded wire when running speakermic wiring and be sure to ground the shield at Veri-Phone™ terminal 10 and nowhere else. **Note:** The Veri-Phone™ will not operate in *VOX* or *Speakerphone Mode* if Speakermics are used.

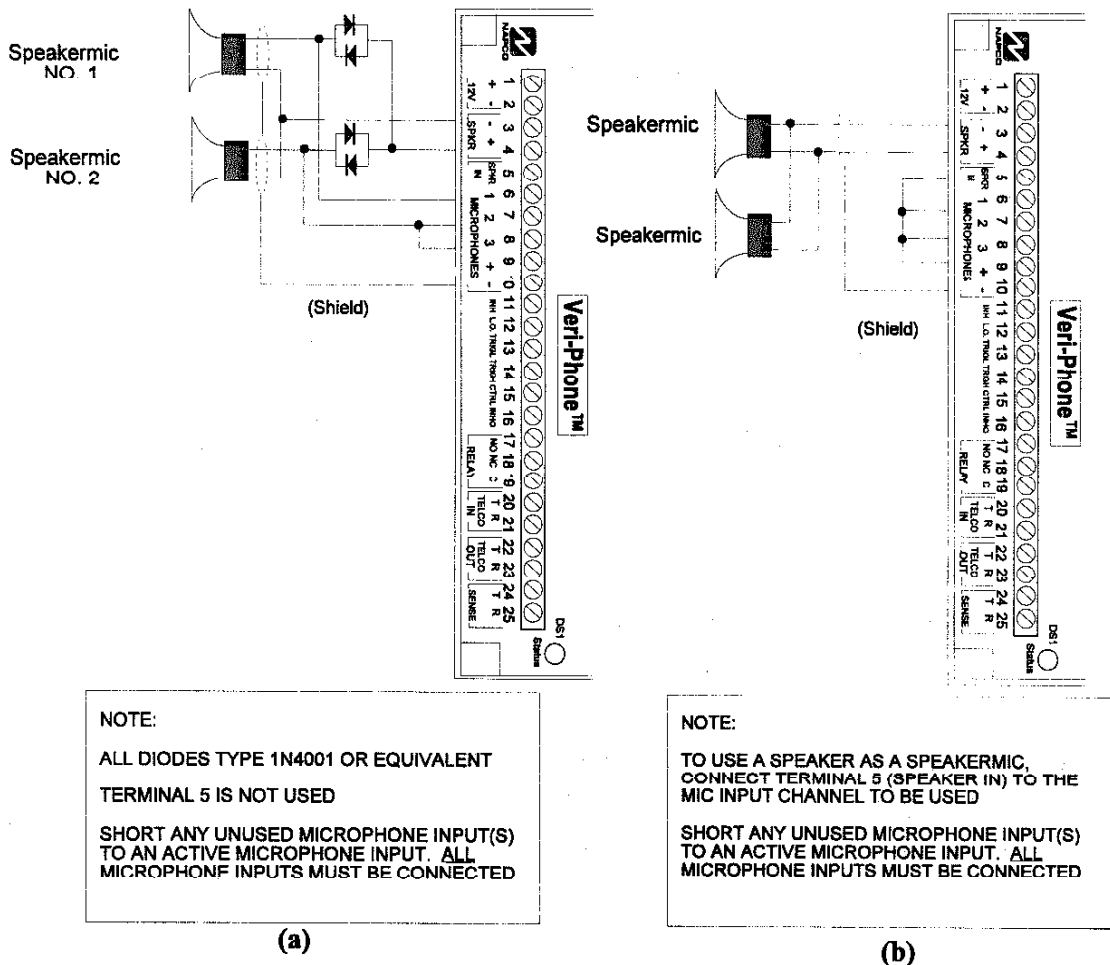

Figure 6(a) **Speakermics Operate Together as Speakers but are Selectable Microphones**
 Figure 6(b) **Speakermics Operate Together as Speakers but Speakermics are not Selectable Microphones**

5. Speakers, Microphones and Speakermics (Continued)

5.4 Microphone and Speaker Selection The quality of a selected component and its placement can mean the difference between a poor and a great performing system. The following components have been tested with the Veri-Phone™ and have proven to work well.

MICROPHONES

Napco	MIC-30
Radio Shack	P/N 270-092
Mouser Electronics	P/N 25LM044 & 25LM051

SPEAKERS

Moose	MPI-35
MG or other	8" public address speakers
Ademco	705-820 (Horn Type)
ATW	H50 (Horn Type)

5.5 Microphone and Speaker placement Mount the speaker at least 2 feet from the microphone. Systems using larger speakers with high output will require more separation, as smaller speakers with lower volume may function well with less separation. Experimentation is recommended. **Note:** Microphone and speaker placement are critical for VOX and *Speakerphone* operation.

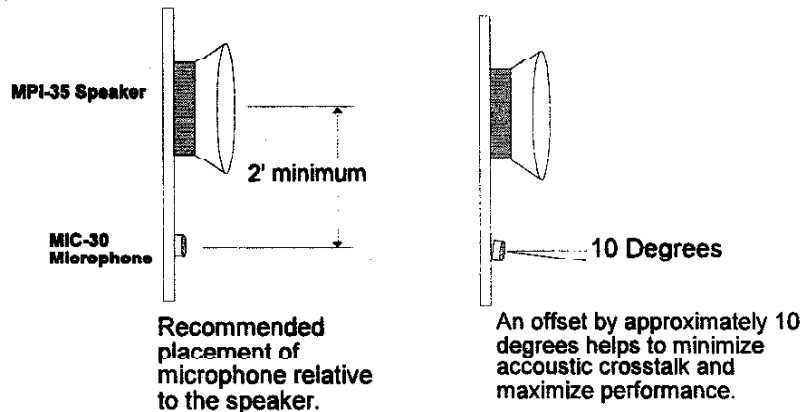

Figure 7 Microphone Placement Relative to Speaker Placement

5.6 Microphone and Speaker Gain Adjustments

1. Power up the control panel, the red Status LED on the Veri-Phone™ should be blinking at a two second rate. This indicates that the Veri-Phone™ is in the *Standby mode* and is operating properly. If the Status LED is not flashing, power down immediately and verify proper wiring.
2. Have your office or a friend Call-in to the Veri-Phone™.
3. First verify adequate volume while in high gain talk (This level will be noticeably louder than when in VOX). If volume levels at this point are low then adjust speaker volume **R67**. If the volume levels are still too low then cut **R37** to boost speaker volume.
4. Ensure that the MIC GAIN pot **R60** is set to the 50% position. Have the person at your office press **[2]** to put the Veri-Phone™ in the VOX mode. Ensure that speaker volume is acceptable for normal conversation. If not make further adjustment to the speaker volume (**R67**). If necessary cut **R37**.

6. Testing

- 6.1 VOX Talk/Listen Switching** When the Veri-Phone™ is in *Talk* or *Listen* mode only one signal path is on at a time. To control which path is on the central station operator or Call-in User must press a button to switch the Veri-Phone™ between *Talk* and *Listen* modes. In VOX/Speakerphone mode the Veri-Phone™ does the switching automatically based on which party is talking. The Veri-Phone™ is constantly monitoring the audio signal from the microphone and comparing it to the signal coming in from the central station over the phone line. Based on which signal is louder the Veri-Phone™ automatically switches between *Talk* and *Listen* modes. How quickly the Veri-Phone™ evaluates who is talking and turns on the appropriate signal path is a measure of how well the system is performing. Proper switching is easiest when one person is talking and the other person is quiet. This is the best situation and is typical of normal conversational speech. However if both parties are talking the circuitry requires more time to determine which path to turn on. This condition is known as an idle state and usually leaves both parties unable to hear or understand the other. The result is that part of the speech of either the central station operator or the person at the premises will be cut off.
- 6.2 VOX Talk/Listen Switching Test** The VOX Talk/Listen Switching Test is meant to ensure that speaker volume, microphone gain and the performance of the VOX Talk/Listen switching test are optimized. No part of the speech in either the *Talk* or *Listen* modes should be cut off.
1. Engage the user calling-in to the Veri-Phone™ in rapid back and forth speech.
 2. If all is working properly then each word will be heard correctly by the other party. If either persons reply is missed or partially blanked, then either speaker volume or microphone gain needs to be reduced. If section 5.6 was followed properly than you probably do not want to reduce speaker volume, thus reduce microphone gain until the VOX Talk/Listen Switching Test produces the desired results. (All words are heard correctly)
Note: This test can also be improved by better separation of the speaker and the microphones.
 3. Have the user calling in switch several times from *Talk* to *Listen* mode and if available, independently switch through microphones 1, 2 and 3. This will insure that the system is switching properly. As a further test turn on any stereos, TV's or anything else that would make the room noisier then usual. Any problems that are noted may be remedied by a further reduction of microphone gain.
- 6.3 Immediate Connect** Call the central station to inform them of the impending test. Before activating the control panel, verify that the house phones are operating. Hang up the house phone and activate the control panel communicator. The red LED will go ON briefly then flash very rapidly. The rapid flashing indicates that the Veri-Phone™ recognizes the control panel and is waiting for it to complete its call. After the control panel completes its call and disconnects, the Veri-Phone™ LED will go ON for a short period of time and then its state will be dependent on the programming of the Veri-Phone™, refer to the Status LED chart on page 5. When the operator disconnects, the LED should revert back to its normal 2-second flashing. Have the Central Station Operator disconnect by using the **[*] [9]** Command. This will activate the *One-Ring Ten Minute Callback Mode*. If a Central Station Operator Access Code was programmed, be sure that the Operator has the correct code. The status LED will be flashing at a one second rate during the 10-minute Callback period.
- 6.4 Automatic Callback Connect** The digital communication to the central station occurs as usual, however after the alarm communication, the Veri-Phone™ will enter the *One-Ring Ten-Minute Callback Mode*. The Veri-Phone™ LED will flash on and off at a 1 rate, indicating that the Veri-Phone™ is in the *One-Ring Ten-Minute Callback Mode*. When the operator calls back the subscriber's premises within ten minutes, the Veri-Phone™ will answer on the first ring and respond to the Operator with a series of three beeps. The operator should then press **[*]**, enter the operator code and press **[*]**. If there was no operator code programmed, simply press **[*]**. When the operator disconnects, the LED should revert back to its normal 2-second on / 2-second off flashing. Repeat this until you are satisfied with the operation.

7. Additional Wiring Options

7.1 Inhibit Control (Terminal 11) This terminal serves two purposes:

7.1.1 Inhibit By Alarm When Terminal 11 (INH) is shorted to Terminal 2 (GND), the Veri-Phone™ will not function. All Veri-Phone™ functions will be inhibited including User Call-in, User and Dealer Programming. A low output from the control panel to this terminal will inhibit the Veri-Phone™ on alarms in which audio verification is undesirable (eg. low battery report).

7.1.2 Speakerphone Operation Similar to VOX mode in that the switching from *Talk* to *Listen* mode is done automatically. If a momentary short to ground (Terminal 2) is applied to INH (Terminal 11) while either a house phone is off hook or ringing, the Veri-Phone™ will pick up the phone and go into Speakerphone operation. A subsequent momentary short to ground will cause a hangup and the Veri-Phone™ will proceed to standby (ready for the next alarm). **Note:** This feature is not available if the Veri-Phone™ is wired for Auto-Sense or Speakermics.

7.2 Listen Only Control (Terminal 12) This terminal serves two purposes:

7.2.1 Listen Only Control If Terminal 12 (LO) is shorted to ground at the start of an audio session, the Veri-Phone™ will allow the central station operator to only access the *Listen Mode* (*TALK Mode* and *VOX Mode* are inhibited). This may be used for silent alarm conditions to prevent the possibility of operator error. This feature may be used by either shorting terminal 12 directly to terminal 2 (LISTEN MODE ONLY) or by allowing an output from the control panel to bring this terminal low only on silent alarms (*TALK* and *VOX modes* permitted for all other alarms).

7.2.2 Privacy If a momentary short to ground is applied while the Veri-Phone™ is currently in an audio session with the central station, the Veri-Phone™ will hang up and proceed to stand by (ready for the next alarm). This feature is used to provide a sense of control to the end user. Either a momentary switch wired to ground (Terminal 2) or a control panel 0 Vdc momentary output of at least 100 milliseconds is required.

7.3 Control Output (Terminal 15) Terminal 15 (CTRL) is an open collector output under operator or user control. This open collector output may be used to pan a video camera or drive a relay for custom applications. See the summary of the selected command set for information on how to activate and deactivate this output. This terminal can be used to sink a maximum of 100 mA to ground.

7.4 Inhibit Output (Module Active Output) (Terminal 16) Terminal 16 (INHO) goes low when the Veri-Phone™ is active. This open-collector output may be wired to a relay for custom applications. The INHO terminal can be used in conjunction with the MA1008e and the MA1016e for keypad and siren silencing and for voice priority. This output can be used to sink a maximum of 15 mA to ground.

7.5 Auto-Sense (Terminals 24, 25) Select Method of Auto-Sense wiring:

7.5.1 Alarm Priority Auto-Sense If connected in accordance with the wiring diagram in Fig. 2, the Veri-Phone™ will be able to determine (by the current in the phone line) if the control panel is off hook and initiate audio verification without the use of a trigger input. Be sure that the Veri-Phone™ is programmed for *Activate with Sense Method*. If a subsequent alarm occurs during audio verification the alarm report will take priority. The control panel will seize the line from the Veri-Phone™ and report the alarm to the Central Station.

7.5.2 Voice Priority Auto-Sense If connected in accordance with the wiring diagram in Fig. 3, the Veri-Phone™ will operate similar to Alarm Priority Auto-Sense except subsequent alarms will not report during audio verification. Be sure that the Veri-Phone™ is programmed for *Activate with Sense Method*. **Note:** It is recommended that the Method of Connection be programmed for *Automatic 10-Minute Callback*, since any failure to report the digital signal on the first attempt (no dial tone, busy signal, etc.) may result in a delay of subsequent attempts if used with the immediate connect method.

8. Additional Features and Options

- 8.1 Auto-Scan** The Veri-Phone™ will sequentially scan each of the three microphone inputs (starting with microphone one). Auto-Scan will monitor each input for 5 seconds. A double-beep will sound in the operator's handset as an indication when microphone one is selected; Inputs 2 and 3 will each sound a single beep. Selecting any command except Reset Safety Timer will stop Auto-Scan. If Auto-Scan is not already active, pressing **[4]** at command level 0 for the SIA command set or a **[#]** for the Standard Command Set will commence Auto-Scan.
- 8.2 User Call-In Mode** The user may call in and access any of the TouchTone commands. The subscriber can use this feature to check on the children, babysitter, elderly persons, etc., when away from home. If an answering machine is connected to the phone, a pause is necessary at the beginning of the recorded message. When the appropriate code is entered, the answering machine will be bypassed. The phone will be answered on a preset number of rings, that is easily changeable either locally or remotely at any time (see User Programming: Number of Rings). After the phone or answering machine has answered, press **[#]**, enter the User Code, then press **[#]** again. The user will automatically be in *Listen mode* (or *VOX mode* if programmed to start up in *VOX*) and all operator functions, except for *One-Ring Ten-Minute Callback Mode*, will be available. **Note:** the user is always allowed to access the *VOX mode* even if Disable Operator for VOX has been programmed.
- 8.3 Operator Access Code** The central station operator can call the Veri-Phone™ only during the *One-Ring Ten-Minute Callback Mode*. The Veri-Phone™ will answer on the first ring and signal for the operator code by sounding three beeps. The operator must then press **[*]** and enter the Operator Code (if used) and **[*]** within 10 seconds. If no Operator Code is programmed, then simply Press **[*]**.
- 8.4 Exclusive Microphone Selection** By default, when a command to turn on any microphone is made, all other microphones will be turned off. For example, turning on mic 1 will cause mics 2 and 3 to turn off. **Note:** The operator will be able to turn on more than one mic at any given time by using the ALL MICS ON command followed by a MIC off command of the undesired microphone (if any).

Programming the Veri-Phone™

9. Dealer Programming

Accessing The Programming Mode

The Veri-Phone™ may be programmed using any TouchTone® telephone, remotely, or locally.

To program **locally**, there are two methods of local Dealer Programming:

Method 1, **Power-Up Programming** (Dealer Code is **not** required to enter the Programming Mode)

1. Power down the Veri-Phone™.
2. Short Trigger Terminal (13) to Ground (2).
3. Pick up the phone that is wired to the Veri-Phone™. (The handset off hook will cause the phone to beep and may cause a telco message. Ignore this and continue).
4. Power up the Veri-Phone™, after approximately 5 seconds, listen for one beep from the speaker connected to terminals 3 and 4, (indicates Veri-Phone™ is in the Programming Mode).
5. Remove short across terminals 13 and 2.
6. Program fields **# 1** through **# 6** or utilize the default program (**# ***). **Note:** fields **# 1** and **# 2** are only available to the dealer through Power-Up programming.
1 and the first 2 digits of **# 6** both set the Number of Rings.

Method 2, **Dealer Programming**

1. Pick up the phone that is wired to the Veri-Phone™. (The handset off hook will cause the phone to beep and may cause a telco message. Ignore this and continue).
2. Press **#**.
3. Enter the Dealer Code.
4. Press ***** Listen for one beep (indicates Veri-Phone™ is in the Programming Mode).
5. Program fields **# 3** through **# 6**, or utilize the default program (**# ***) to load fields **# 3** through **# 6** with the default program.

To program the Veri-Phone™ remotely:

1. Call the phone wired to the Veri-Phone™.
2. Wait for an answer (indicated by three beeps) and press **#**.
3. Enter the Dealer Code. (During pause in recorded message)
4. Press *****, and listen for one beep, (indicates Veri-Phone™ is in the Programming Mode).
5. Program fields **# 3** through **# 6**, or utilize the default program (**# ***) to load fields **# 3** through **# 6** with the default program.

To Reset The Veri-Phone™ to its factory default settings

Press **# *** (This will default the Dealer Code if programmed.)

Note: The User Code will be changed to the factory default of 1,2,3,4,5,6 only through Power-Up Programming.

To Exit Dealer Programming Enter **# 8 Dealer Code ***

To Exit Dealer Programming and disable the Veri-Phone™ for 10 minutes to download to the Control Panel

Enter **# 9 Dealer Code ***.

VERI-PHONE™ AUDIO VERIFICATION MODULE

9. Dealer Programming (Continued)

Follow These Steps To Program Your Veri-Phone™: Default Programming shown in Parentheses

- [1] **Dealer Security Code.** Default (4,5,6,7,8,9)
A Dealer Security Code of up to 6 digits may be programmed. This code must be changed in order to maintain security.

Press **# 3** one beep will sound.

Enter New Dealer Code 1-6 Digits

Press *** 1** two beeps will sound.

(4)(5)(6)(7)(8)(9)

[2] **# 4** Programming - **Hardware Configuration Information**

Method of Veri-Phone™ Activation • Fast Trigger Operation • Activate in Listen or VOX • CSAVM Operation • Exclusive Microphone Selection • State of Microphones at the beginning of Audio Verification •

- 2.1 **Trigger or Sense Method of Veri-Phone™ Activation?** Default: Trigger Method (0)
Select whether the Veri-Phone™ is wired for Trigger or Sense Method

Press **# 4** one beep will sound

Enter (0) for Trigger Method

Enter (1) for Auto-Sense Method

(0)

- 2.3 **Fast Trigger Operation?** Default: Normal Trigger Operation (0)
Select whether the Veri-Phone™ will activate with a 1 second trigger or a 5 second trigger.

Enter (0) Normal Trigger

Enter (1) Fast Trigger

(0)

- 2.3 **Activate with Listen or VOX Mode?** Default: Activate in Listen Mode (0)
Select whether the Veri-Phone™ will commence Audio Verification in the *Listen* or *VOX Mode*.

Enter (0) Listen Mode.

Enter (1) VOX Mode.

(0)

- 2.4 **Enable CSAVM Operation?** Default: NO (0)
Select whether the Central Station is equipped with a CSAVM

Enter (0) Disable operation with a CSAVM

Enter (1) Enable operation with a CSAVM

(0)

- 2.5 **Disable Exclusive Mic Selection?** Default: NO (0)
When a command to turn on any microphone is made, all other microphones will be turned off. For example, turning on mic 1 will result in mics 2 and 3 to turn off. Note: The operator will be able to turn on more than one mic at any given time by using the ALL MICS ON command followed by a MIC off command of the undesired microphone (if any).

Enter (0) for No

Enter (1) for Yes

(0)

9. Dealer Programming (Continued)

2.6 State of Microphones at the beginning of Audio Verification? Default: All Mics on (0)
 Select whether to commence audio verification with Mic 1 on, or with all Mics on,

Enter (0) for All Mics on
 Enter (1) for Mic 1 (0)

Press **[*]** to make change permanent. Two beeps will be heard (seven beeps indicates an error condition, if an error occurs repeat steps 2.1 through 2.6).

[3] [#] [5] Programming - Operator Information

Veri-Phone™ Activation • Method of Connection • Standard or SIA Command Set •
 Operator VOX • Operator Access code (optional)

3.1 Disable Veri-Phone™ Activation? (Trigger/Auto-Sense Inputs) Default: NO (0)
 Disables the initiation of an Audio Session due by either trigger or sense method of Alarm detection.

Press **[#] [5]** one beep will sound
 Enter (0) for No
 Enter (1) for Yes (0)

3.2 Method of Connection ? Default: Direct (0)
 If Immediate Connection is selected the Veri-Phone™ will seize the phone lines after alarm activation.
 If Automatic 10-minute Callback is selected the Veri-Phone™ will automatically enter 10-minute
 Callback after each alarm activation.

Enter (0) for Immediate Connection
 Enter (1) for Automatic 10-minute Callback (0)

3.3 Enable Standard or SIA Command Set for the Operator? Default: Standard (0)
 Select either the Standard or SIA command set for the Operator.
 Refer to Selecting the Standard or SIA Command Set on page 23.

Enter (0) for Standard
 Enter (1) for SIA (0)

3.4 Operator VOX Mode Disabled? Default: NO (0)
 Disable the operator's ability to enter the VOX mode.

Enter (0) for No
 Enter (1) for Yes (0)

3.5 Operator Access Code (Optional)

If Not Programming An Operator Code, PRESS **[*] and Skip Step 3.5**

The Central Station Operator can only access the Veri-Phone™ with this code when the Veri-Phone™ is in the *One-Ring Ten-Minute Callback Mode*. Speak with your Central Station prior to programming this code.

Enter Operator Access Code 1-3 Digits (Optional)
 Press **[*]** to make change permanent.
 Two beeps will be heard (seven beeps indicates an error condition,
 if an error occurs repeat steps 3.1 through 3.5).

9. Dealer Programming (Continued)

[4] [#] [6] Programming - User Information

Number of Rings • User Call-In

4.1 Number Of Rings? Default: (13)

Press [#] [6] one beep will sound
Enter The Number Of Rings (01 - 13) (Must Be A Two Digit Number)
(1)(3)

4.2 User Call-In Disabled? Default: NO (0)

User Call-In is a feature designed to allow users access to their Veri-Phone™ using TouchTone commands. If this feature is enabled, the User Access Code must also be programmed. The default User Access Code is 1,2,3,4,5,6 and can be changed by following the instructions in User Programming on page 22. Refer to User Operation For User Call-In Instructions.

Enter (0) for No
Enter (1) for Yes (0)

Press [*] to make change permanent. Two beeps will be heard (seven beeps indicates an error condition, if an error occurs repeat steps 4.1 and 4.2).

[5] Exit Dealer Programming

Press [#] [8] one beep will sound.
Enter Your Dealer Code.
Press [*] two beeps will sound and the Veri-Phone™ will disconnect.

If Downloading to a control panel, the Veri-Phone™ Call-In must first be temporarily disabled. To download and disable the Veri-Phone™ call in for ten minutes, follow these instructions:

Exit Dealer Programming and Disable Veri-Phone™ for 10 Minutes. (Allows time to Download to the Control Panel).

Press [#] [9] One beep will sound.
Enter Your Dealer Code.
Press [*] two beeps will sound and the Veri-Phone™ will disconnect.

VERI-PHONE™ PROGRAMMING WORKSHEET - SHEET 1

(DEFAULT PROGRAM SHOWN IN PARENTHESES)

Customer Name _____ Account _____ Phone # _____

TO ENTER PROGRAMMING MODE: (CHOOSE ONE METHOD)

- **POWER-UP PROGRAMMING**
 - 1) Take phone off hook
 - 2) Short the Trigger Input (TRGL) to ground (TERM 2 to Term 13)
 - 3) Power-up unit (Beep after 5 seconds)
 - 4) Remove short
 - 5) Program unit using touch pad of telephone
- **LOCAL PROGRAMMING**
 - 1) Pick up local phone.
 - 2) Enter (4) (5) (6) (7) (8) (9) (Beep) Dealer Code
 - 3) Program unit using touch pad of telephone.
- **REMOTE PROGRAMMING**
 - 1) Call the phone number connected to the Veri-Phone™, wait for an answer (Beep)(Beep)(Beep).
 - 2) Enter (4) (5) (6) (7) (8) (9) (Beep) Dealer Code
 - 3) Program unit using touch pad of telephone.

NOTE: A speaker must be wired between terminals 3 & 4 in order for the feedback beeps to be heard in POWER-UP and LOCAL PROGRAMMING.

NOTE: Ignore recorded TELCO message on phone during POWER-UP and LOCAL PROGRAMMING.

NOTE: If an answering machine picks up before the Veri-Phone™ picks up on Ring Count, enter Dealer Code during pause in answering machine message to override.

To Program the Veri-Phone™, enter the following keystrokes on the TouchTone phone. Feedback beeps will confirm proper programming - (7 beeps indicate an invalid entry, re-enter field).

- **To Enter the Default Program:** Note: The User Code is changed to the default factory settings only through Power-Up Programming
 (Beep) PAUSE (Beep)(Beep) (Loads default program shown in parentheses)
- **To Change User Code:**
 (Beep) (1) (2) (3) (4) (5) (6) (Beep) (Beep) (If Less Than 6 Digits Press When Done) (For Power-Up Programming Only)
- **To Change Dealer Code:**
 (Beep) (4) (5) (6) (7) (8) (9) (Beep) (Beep) (If Less Than 6 Digits Press When Done)
- **To Change Hardware Configuration Options:**
 (Beep) (0) (0) (0) (0) (0) (0) (Beep)(Beep) **Hardware Configuration Information**

Note: Dealer Programming timeout (indicated by 7 error beeps) occurs if the Veri-Phone™ does not receive TouchTone commands for more than 1 minute. If necessary re-enter Dealer Programming.

<p>Select Method of Veri-Phone™ Activation. Trigger or Sense Method? 0 = Trigger Method 1 = Sense Method</p> <p><small>If using an Control Panel that has a Listen-in, NTO or PGM Lug select the Trigger Method.</small></p>	<p>Enable Fast Trigger? 0 = NO 1 = YES</p> <p><small>If required select a 1 second trigger instead of a 5 second trigger.</small></p>	<p>Activate with Listen or VOX Mode? 0 = Listen Mode 1 = VOX Mode</p> <p><small>Select the state in which the Veri-Phone™ will initiate the Audio Session.</small></p>	<p>Enable CSAVM Operation? 0 = NO 1 = YES</p> <p><small>If the Central Station is equipped with a CSAVM, enable the Veri-Phone™ for CSAVM operation.</small></p>	<p>Disable Exclusive Microphone Selection? 0 = NO 1 = YES</p> <p><small>Disables individual microphone selection.</small></p>	<p>Activate The Audio Session with Microphones in 0 = All Mics ON 1 = Mic 1 ON</p> <p><small>Select the state of the microphones at the start of the audio session.</small></p>
---	--	---	---	--	--

VERI-PHONE™ PROGRAMMING WORKSHEET - SHEET 2

(DEFAULT PROGRAM SHOWN IN PARENTHESES)

● To Change Operator Options:

5 (Beep) *** (Beep)(Beep)** Operator Information

<p>Disable Veri-Phone™ Activation? 0 = NO 1 = YES</p> <p>Disables the initiation of an audio session by either trigger or sense method of Veri-Phone™ activation.</p>	<p>Method of Connection? 0 = Immediate 1 = Automatic 10- Minute Callback</p> <p>If the Immediate Method is selected the Veri-Phone™ will seize the phone lines after alarm activation.</p> <p>If Automatic 10-Minute Callback is selected the Veri-Phone™ will automatically enter the Callback mode after each alarm activation.</p>	<p>Select the Standard or SIA Command Set for the Operator? 0 = Standard 1 = SIA</p> <p>Select whether the operator will use the Standard or SIA Command set.</p>	<p>Disable OperatorVOX? 0 = NO 1 = YES</p> <p>Disables the operator's ability to enter the VOX mode.</p>	<p>* Operator Access Code (Optional for High Security Callback Connect)</p> <p>Program only if High Security Callback Connect is required.</p>
--	--	--	---	---

*The first four options must be programmed whenever the **# 5** field is entered if no Operator Access Code is desired, press ***** after the fourth digit.

● To Change User Options:

6 (Beep) *** (Beep)(Beep)** User Information

<p>Number of Rings?</p> <p>The number of rings it takes the Veri-Phone™ to answer during User Call-In, User and Dealer Programming</p>	<p>Disable User Call-in? 0 = NO 1 = YES</p> <p>If User Call-in is disabled the Veri-Phone™ will not respond to the User code and initiate an audio session.</p>
---	--

To Exit Dealer Program Mode:

Dealer Code
8 (Beep) *** (Beep) (Beep) (Disconnect)**

To Exit Dealer Program Mode and Disable the Veri-Phone™ for 10 Minutes to Download to the Control Panel:

Dealer Code
9 (Beep) *** (Beep) (Beep) (Disconnect)**

Allows the Control Panel to Pick-Up if Downloading.

10. User Programming

The **User Call-In Mode** is a feature designed to allow a user access to his Veri-Phone™ using TouchTone commands. A user may only access the Veri-Phone™ with the correct **User Access Code**. The phone will be answered by the Veri-Phone™ at a programmable **Number Of Rings**. If an answering machine or person picks up the phone before the programmed number of rings it may be bypassed by entering the **User Access Code** during the pause in the recorded message. These two features may be programmed by following the steps below. Please note that the Number Of Rings may also be programmed in Dealer Programming. The **User Access Code** can only be defaulted through Power-Up Programming.

User features may be programmed either locally or remotely as follows:

Local Programming:

1. Pick up the local phone and Press **#**.
2. Enter the default User Code (1,2,3,4,5,6)
3. Press ***** one beep will sound at the speaker.

Remote Programming:

1. Call the phone wired to the Veri-Phone™, wait for an answer, indicated by three beeps, press **#**.
2. Enter the default User Code (1,2,3,4,5,6)
3. Press ***** one beep will sound.

When the confirmation beep sounds, **EITHER** The Number of Rings Feature **OR** The User Access Code feature may be programmed per access. If both features will be programmed, repeat the steps above for the second feature. Local Users will hear the confirmation beep at the speaker only and the remote user will hear the confirmation beep through the phone only.

[1] Number Of Rings?

The Number Of Rings, (1-13) that the Veri-Phone™ on will answer in the *Call-In Mode*.

Press **# 1**, one beep will sound.
 Enter the Number Of Rings (01 - 13)
 Press ***** two beeps will sound.
 The Veri-Phone™ will disconnect

 (1)(3)

[2] User Access Code. Default: (1,2,3,4,5,6)

Remember, **only one feature** is programmable per access. If you have already programmed the Number Of Rings, you must follow the steps for gaining access either locally or remotely before entering a User Access Code.

Press **# 2** one beep will sound
 Enter new User Access Code 1-6 Digits
 Press ***** two beeps will sound.
 The Veri-Phone™ will disconnect.

 (1)(2)(3)(4)(5)(6)

After each valid entry, 1 beep will sound. After an invalid entry, 7 beeps will sound. Repeat current step if an invalid entry is made.

11. Control of the Veri-Phone™ Using a TouchTone® Phone

11.1 Selecting the Standard or SIA Command Set There are two command sets available to the operator, the Standard Command Set and the SIA Command Set. Contact the Central Station to determine the operator command set.

11.2 OPERATION using the Standard Command Set Using a TouchTone® phone, the following commands can be accessed by pressing their respective keys. Second Functions can be accessed by first pressing **[*]**, then the key of the desired second function. The shaded box below the key indicates the second function of the key.

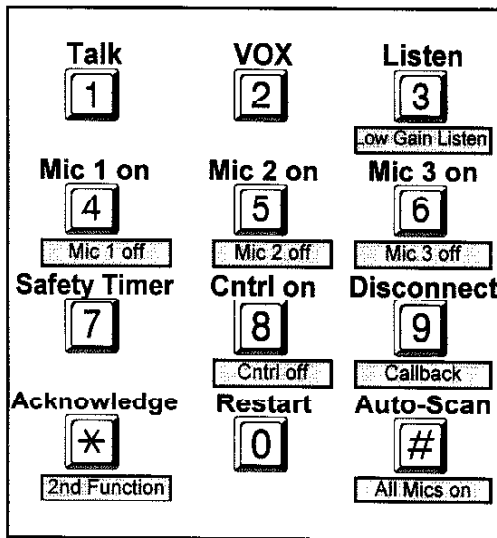

Standard Command Set

The shaded box below the key indicates the second function of the key. Use the **[*]** key and the key of the desired second function to access the function.

Ex: To turn off Mic 3 press **[*]** **[6]**

[0] Restart. This command will return the Veri-Phone™ to its initial settings at the beginning of the audio session.

[1], **[2]** & **[3]** **Talk, VOX & Listen.** When the Veri-Phone™ has been accessed, it will be in either *Listen Mode* or *VOX Mode* depending upon which has been selected in Dealer Programming. The operator may switch between *Talk*, *VOX* and *Listen* by pressing their respective keys. If the Veri-Phone™ remains in this mode with no activity (no commands being accessed), it will sound two warning beeps 15-seconds prior to disconnecting. The operator or user can remain undetected in the *Listen Mode* as long as desired by pressing **[7]** within the 4 minute timeout period when the warning beeps are heard.

[4], **[5]** & **[6]** **Listen to Microphones 1, 2, & 3.** Microphone selection is accomplished by pressing the **[4]**, **[5]** or **[6]** keys on a handset for Microphone 1, 2, or 3, respectively. Pressing the **[#]** key will cause the Veri-Phone™ to scan all three microphones. Microphones can be turned off by pressing the Second Function Key (**[*]**) and the **[4]**, **[5]** or **[6]** keys on a handset for Microphone 1, 2, or 3, respectively. Microphones can be selected exclusively if Exclusive Microphone Selection has been programmed in Dealer Programming.

11.2 OPERATION using the Standard Command Set (Continued)

7 **Restart Safety Timer** After the Veri-Phone™ has been accessed, a 4-minute Timer starts (One minute for CSAVM operation). If the Veri-Phone™ remains in a mode with no activity, (no commands being accessed) it will sound two warning beeps 15-seconds prior to disconnecting. Pressing the **7** key, or any other key (except **9**) will reset this timeout period for another 4 minutes. During Listen, pressing **7** will not be heard at the subscribers premise. The operator or user can remain undetected in the *Listen Mode* as long as desired by pressing **7** within the 4 minute timeout period. Pressing any other command will also reset the timer.

8 **Control Output** Turns on the an open collector output (Terminal 15). Pressing the Second Function key ***** and the **8** key will turn off the Control Output.

9 **Disconnect** This command will disconnect the Veri-Phone™. Disconnect and Activate Callback Mode can be activated by pressing the Second Function key ***** then the **9** key. This command will disconnect the Veri-Phone™ and will cause the Veri-Phone™ to enter the *One-Ring Ten-Minute Callback Mode*. This means that the Veri-Phone™ will answer on the first ring for a 10 minute period.

***** **Acknowledge on Callback and Second Function**

- **Acknowledge on Callback** When calling the Veri-Phone™ in the *One-Ring Ten-Minute Callback Mode*, the Veri-Phone™ will respond with three beeps upon answering. The operator must then press ***** and enter the Operator Code (if used) and ***** within 10 seconds. If no Operator Code is programmed, then simply press *****.
- **Second Function** To access a key's second function press ***** then the key of the desired second function.

**Auto-Scan** Pressing the **#** key will initiate Auto-Scan, causing the Veri-Phone™ to automatically scan the three microphone inputs in sequence for 5 seconds each, starting with microphone 1. A double beep will sound in the operator's handset to identify microphone 1 Input. Microphone 2 and 3 will each sound one beep. Selecting any command except **7** will stop Auto-Scan and pressing **#** will resume Auto-Scan.

VERI-PHONE™ AUDIO VERIFICATION MODULE

11.3 OPERATION using the SIA Command Set Using a TouchTone® phone, the following commands can be accessed by pressing their respective keys.

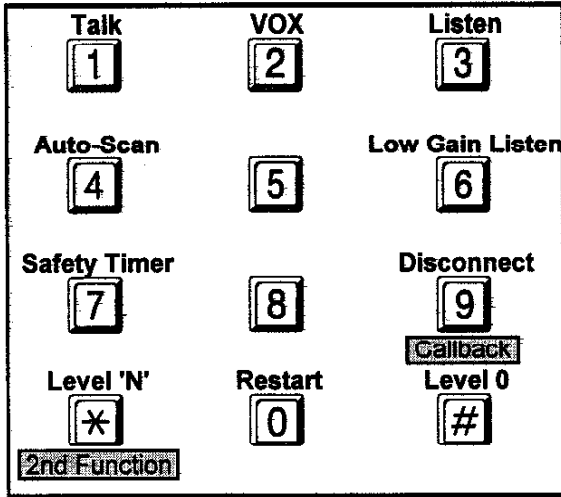

Level 0 - SIA Command Set

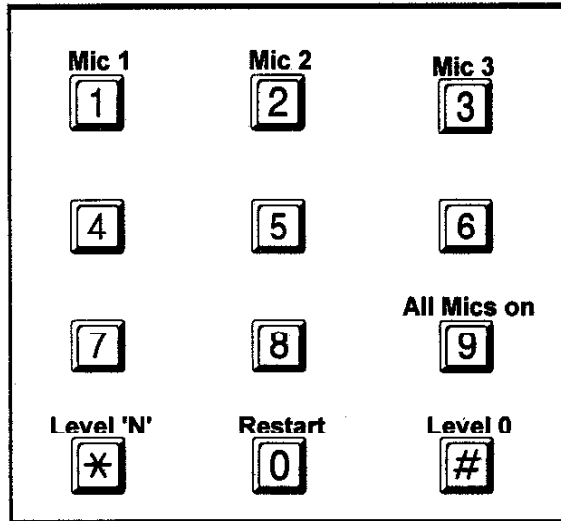

Levels 1, 2 & 3 - SIA Command Set

- Level 1 - Command toggles microphones on and off.
- Level 2 - Command turns off specified microphone.
- Level 3 - Command turns on specified microphone.

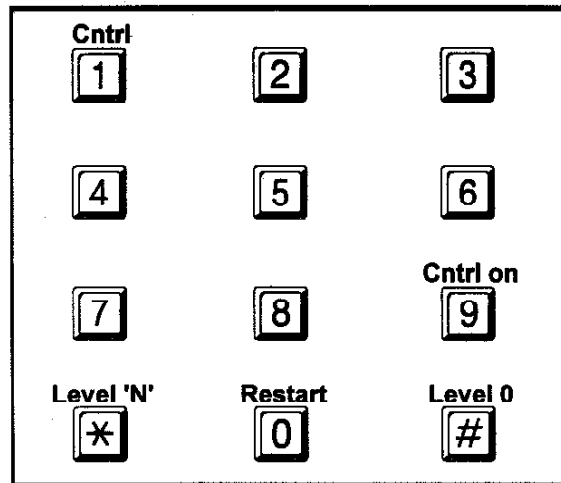

Levels 4, 5 & 6 - SIA Command Set

- Level 4 - Toggles the control output on and off.
- Level 5 - Turns the control output off.
- Level 6 - Turns the control output on.

11.3 OPERATION using the SIA Command Set (Continued)

Level 0

- [1], [2] & [3]** **Talk, VOX & Listen** While in Level 0 of the SIA command set. The operator may switch between Talk, VOX and Listen by pressing their respective Keys.
- [4]** **Auto-Scan All Microphone Inputs** Pressing the **[4]** key will initiate Auto-Scan, causing the Veri-Phone™ to automatically scan the three microphone inputs in sequence for 5 seconds each. A double beep will sound in the operator's handset to identify microphone 1 Input. Microphone 2 and 3 will each sound one beep. Selecting any command except **[7]** (Reset Safety Timer) will stop Auto-Scan. Pressing **[4]** from Level 0 will resume Auto-Scan.
- [7]** **Restart Safety Timer** After the Veri-Phone™ has been accessed, a 4-minute timer starts (one minute for CSAVM operation). If the Veri-Phone™ remains in a mode with no activity no commands being accessed), it will sound two warning beeps 15-seconds prior to disconnecting. Pressing the **[7]** key, or any other key (except **[9]**) will reset this timeout period for another 4 minutes. During Listen, pressing **[7]** will not be heard at the subscriber's premises. The operator or user can remain undetected in the Listen Mode as long as desired by pressing **[7]** within the 4 minute timeout period when the warning beeps are heard.
- [9]** **Disconnect** This command will disconnect the Veri-Phone™. Disconnect and Activate Callback Mode can be activated by pressing the **[*][9]** key combination. This command will disconnect the Veri-Phone™ and will cause the Veri-Phone™ to enter the *One-Ring 1en-Minute Callback Mode*. This means that the Veri-Phone™ on the premises will allow the central station ten minutes to call back and will answer the call on the first ring.

Level 1, 2 and 3

- [1], [2] & [3]** **Microphone Controls** Pressing **[1]**, **[2]** or **[3]** will toggle the respective microphone on and off while in level 1, turn off the respective microphone while in level 2, and turn on the respective microphone while in level 3. Microphones will be selected exclusively while in level 3 if Exclusive Microphone Selection is enabled in Dealer Programming.
- [9]** **All Microphones On** Turns on all Microphones from level 1, 2 or 3.

Level 4, 5 and 6

- [1]** **Control Output** Turns on the an open collector output (Terminal 15). The Control Output can be toggled on and off while in level 4. The Control Output can be turned off while in level 5. The Control Output can be turned on while in level 6.
- [9]** **Control Output On** Turns the control output on from level 4, 5 or 6.

Commands Common to all levels

- [*]** **Level 'N'** Access any level by pressing **[*]** then the key of the desired level.
- [0]** **Restart** This command will return the Veri-Phone™ to its initial settings.
- [#]** **Level 0** Access level 0 from any level by pressing **[#]**.

12. User Call-in; Gaining Access

1. User calls premises
2. Veri-Phone™ will pick up on programmed number of rings
User will hear 3 beeps on pickup.
3. User presses **[#]** enters (User Access Code) **[#]**. (Enter User Access Code during pause of answering machine to override)
4. Veri-Phone™ will seize phone line and initiate an audio session.
5. User can control the Veri-Phone™ using TouchTone® Commands.

The subscriber can use this feature to check on the children, babysitter, elderly persons, etc., when away from home.

13. Central Station Operation and Requirements

13.1 Central Station Requirements When a control panel equipped with an Veri-Phone™ communicates an alarm to the central station receiver, there are several ways to access the audio verification mode of the Veri-Phone™. The method chosen will depend upon the type of central station receiver being used, the presence of a NAPCO CSAVM, and the preference of the central station (Immediate Connect or Automatic Callback Connect). The Veri-Phone™ will operate with any receiver capable of audio verification. If it is to be used on a receiver that does not support audio verification, the CSAVM must be used. The CSAVM is installed on the incoming phone line of the receiver, and supports a side phone for the operator to listen/talk to the premises. It is capable of detecting the presence of an Veri-Phone™ equipped control panel and seizing the phone line upon kissoff, initiating audio verification.

13.2 Central Station Operation When an audio session has been initiated, the unit will be in either *VOX* or *Listen mode* depending on Dealer Programming. The microphones will be set for either all mics on or Mic 1 on depending on Dealer Programming. If the Veri-Phone™ is set for Auto-Scan, the Veri-Phone™ will be automatically scanning each microphone input for 5 seconds starting with microphone 1. There will be two beeps at the beginning of the scan of microphone 1, and one beep at the beginning of the microphone 2, and 3 scans. This allows the operator to determine which microphone zone shows activity. Using TouchTone commands, the operator may switch to monitoring only one active area. If desired, the operator may speak to the occupants to verify the alarm condition. To terminate the two-way voice session, the operator will simply press **[9]** hang up, or press **[*][9]** and hang up to put the Veri-Phone™ into a *One-Ring Ten-Minute Callback Mode*. While in the Listen Mode, the operator may notice a brief, barely perceptible pause every 5 seconds. This pause is a unique feature that assures the operator positive switching using TouchTone commands, regardless of the background noise at the premises. If the Veri-Phone™ will not respond to TouchTone commands, the key must be held for 5 seconds. The Central Station should obtain any required advance consent of the user prior to this procedure.

The Standard and SIA Command sets on pages 23 through 26 provide a listing of commands and their respective features that can be accessed using a TouchTone® phone. The Veri-Phone™ can operate in two different Central Station Modes, each of which is discussed below.

1- CSAVM Operation-	Immediate Connect /AutomaticCallback Connect.
2- NON-CSAVM Operation-	Immediate Connect /AutomaticCallback Connect.
	Listen-In Receiver Required for Immediate Connect.

13. Central Station Operation and Requirements (Continued)

13.3 CSAVM Operation (Central Station CSAVM Required) Program the Veri-Phone™ for enable CSAVM OPERATION in Dealer Programming. The Central Station must be equipped with a CSAVM Two-Way Voice Interface for each incoming line that the Veri Phone™ will be connected. When the CSAVM is used with a standard receiver and a call is received from a control panel equipped with an Veri-Phone™, the CSAVM will then ring a standard phone, multiline keyset or PBX, informing the operator that a voice call is on the line.

13.3.1 Immediate Connect Method has been programmed for the Veri-Phone™, CSAVM is programmed for Receiver Line Management and a call is received:

1. Operator picks up the phone connected to the phone jack at the back of the CSAVM and the Veri-Phone™ has initiated an audio session.
2. Operator may use the TouchTone commands of either the Standard or SIA command set, depending upon which has been selected through Dealer Programming, to control the Veri-Phone™.
3. Call is terminated by hanging up the phone OR
4. Operator can disconnect and Callback by pressing ***9**. (Disconnects and Activates *One-Ring Ten-Minute Callback Mode*).

13.3.2 Automatic Callback Connect has been programmed for the Veri-Phone™, a call is received the Veri-Phone™ goes into the *One-Ring Ten-Minute Callback Mode*. Note: A separate phone line for the CSAVM is required.

1. Operator must call the premises and the CSAVM will access the Veri-Phone™ and automatically send an operator code (if programmed).
2. Operator may use the TouchTone commands of either the Standard or SIA command set, depending upon which has been selected through Dealer Programming, to control the Veri-Phone™.
3. Call is terminated by hanging up the phone OR
4. Operator may disconnect and Callback by pressing ***9**.

NOTE: Upon termination of the call (when the operator hangs up), the CSAVM will automatically send a command to the Veri-Phone™ to prompt it to also hang up. If for any reason, the call is interrupted and terminated, the Veri-Phone™ will hang up within 60 seconds. This is due to a Restart Safety Timer (Command **7**) that is sent automatically from the CSAVM to the Veri-Phone™ every 45 seconds. This timeout applies to the Veri-Phone™ only when used with the CSAVM. If the CSAVM is not used by the central station, an interruption in communication could result in a 4 minute timeout before the Veri-Phone™ hangs up.

13.4 NON-CSAVM Operation (No CSAVM Required) Program the Veri-Phone™ for Non-CSAVM operation in Dealer Programming. With this method, the central station receiver must have Two-Way Voice capability. Set up the receiver so that the accounts to which the Veri-Phone™ will be connected will be in the *Listen mode*. The receiver hold-time must be set long enough for the operator to pick up the phone that is connected to the same line as the receiver. When a call is received, the central station line receiver will hold the line open until the operator picks up the phone.

13. Central Station Operation and Requirements (Continued)

13.4.1 Immediate Connect Method has been programmed for the Veri-Phone™ and a call is received:

1. Operator picks up the phone connected to the two-way voice ready Receiver.
2. Operator may use the TouchTone commands of either the Standard or SIA command set, depending upon which has been selected through Dealer Programming, to control the Veri-Phone™.
3. Operator must terminate the call by one of the following three methods:
 - (a) Press **9**. Disconnects.
 - (b) Press ***9**. Disconnects and activates *One-Ring Ten-Minute Callback Mode*.
 - (c) Let the Veri-Phone™ at the premises timeout (1 minutes) and disconnect itself. The Veri-Phone™ will then go into a *One-Ring Ten-Minute Callback Mode*. (Not Recommended) If the wrong operator code or no operator code is received, the 10 minute time period will continue and the Veri-Phone™ will disconnect and await a call with the correct operator code.

13.4.2 Automatic Callback Connect has been programmed for the Veri-Phone™, A call is received and the Veri-Phone™ goes into the *One-Ring Ten-Minute Callback Mode*:

1. Operator must call the premises, and enters ***x** (or ***x** plus operator code, if programmed).
2. Operator may use the TouchTone commands of either the Standard or SIA command set, depending upon which has been selected through Dealer Programming, to control the Veri-Phone™.
3. Operator hears three beeps and is in voice communication with the premises.
4. Operator may use the TouchTone commands of either the Standard or SIA command set depending upon which has been selected through Dealer Programming.
5. Operator must terminate the call by one of the following three methods:
 - (a) Press **9**. Disconnects.
 - (b) Press ***9**. Disconnects and activates *One-Ring Ten-Minute Callback Mode*.
 - (c) Let the Veri-Phone™ at the premises timeout (4 minutes) and disconnect itself. The Veri-Phone™ will then automatically go into a *One-Ring Ten-Minute Callback Mode*. (not recommended) If the wrong operator code or no operator code is received, the 10 minute time period will continue and the Veri-Phone™ will disconnect and await a call with the correct operator code.

Troubleshooting

SYMPTOM	SOLUTION
Veri-Phone™ will not pick up when being called	<ol style="list-style-type: none"> 1. Veri-Phone™ is still In Dealer Mode. 2. No telephone or capacitor across terminals 22 & 23 (TELCO OUT). 3. Veri-Phone™ disabled for the 10-Minute Download period. 4. Veri-Phone™ INH input is shorted to ground.
Veri-Phone™ will not trigger on alarm (Trigger Method being used)	<ol style="list-style-type: none"> 1. Veri-Phone™ is programmed for the Auto-Sense Method. 2. Veri-Phone™ is still in Dealer Mode. 3. TRIG wire not connected properly. Check Veri Phone™ and panel wiring. 4. Veri-Phone™ INH input is shorted to ground.
Veri-Phone™ will not trigger on alarm (Auto-Sense Method of wiring)	<ol style="list-style-type: none"> 1. Veri-Phone™ is programmed for the Trigger Method. 2. Veri-Phone™ INH input is shorted to ground.
Veri-Phone™ always goes Into Callback after an alarm.	<ol style="list-style-type: none"> 1. Veri-Phone™ programmed for CSAVM Operation and Central Station is not equipped with a CSAVM. 2. Veri-Phone™ is programmed for Automatic Callback. Program the Veri-Phone™ for Immediate Method of Connection.
Unable to get into the Programming Mode.	<ol style="list-style-type: none"> 1. Wrong Dealer Code being used. Force Dealer Mode by powering up with TRIGL grounded. 2. Incorrect voltage at terminals 1 and 2. 3. Veri-Phone™ INH input is shorted to ground.
Unable to exit Dealer Mode.	<ol style="list-style-type: none"> 1. Code entered does not match programmed code. Reprogram Dealer Code and reattempt exiting.
Veri-Phone™ will not switch to Talk or VOX.	<ol style="list-style-type: none"> 1. L.O. lug wired to ground. 2. Adjust mic gain. 3. Hold down the [M] key for at least 5 seconds.
Listen Mode not working (using Speakermics).	<ol style="list-style-type: none"> 1. MIC Input(s) not connected. Connect short from SPKIN (Terminal 5) to the malfunctioning MIC Input(s).
Phone Company tones are sounding over the phone while in Program Mode.	<ol style="list-style-type: none"> 1. These tones may be ignored while in the Program Mode. Continue entering the required TouchTone® digits.
Unit Triggers into Listen Mode but the Central Station never picks up (Central Station is equipped with a CSAVM).	<ol style="list-style-type: none"> 1. The Veri-Phone™ is not programmed for CSAVM Operation
High background noise.	<ol style="list-style-type: none"> 1. Adjust MIC Gain Up or Down. 2. Use shielded wire making sure that the shield is connected to ground ONLY AT Terminal 10.
Central Station has difficulty hearing while in the Listen Mode.	<ol style="list-style-type: none"> 1. Increase the MIC Gain, adjust the MIC gain control (R60) clockwise.
Parts of speech of the user or operator are cut off.	<ol style="list-style-type: none"> 1. Re-check microphone and speaker placement, re-check MIC gain control and speaker volume. Refer to the VOX switching Test.
Speakerphone does not work.	<ol style="list-style-type: none"> 1. The Veri-Phone™ is wired for the Auto-Sense Method. 2. The Veri-Phone™ is wired for Speakermics.

Table 2

VERI-PHONE™ AUDIO VERIFICATION MODULE

Specifications

Input Voltage: 12Vdc
 Current Drain: Standby, 40 mA; Active, 180mA
 INH Output (Module Active): Open Collector, 15 mA maximum
 Control Output: Open Collector, 100 mA maximum
 Speaker Impedance: 4 Ohm, minimum
 Relay: Form C; Contact Ratings, 5A/30Vdc
 Housing Dimensions: Veri-Phone™, 7.0"L x 4.75"W x 1.38"H
 MRAV-30, 4.38"L x 2.5"W x 0.94"H

Ordering Information

Veri-Phone™ Audio Verification Module
MRAV-30 Matching Keypad Style Unit With Dual Function 8 Ohm Speakermic.
CSAVM Central Station Two-Way Voice/Audio Verification Interface with Power Transformer
MIC-30 Optional Microphone and Acoustic Insulator

Veri-Phone™ to Napco Control Panel Wiring Table:

Veri-Phone™	MA1008LKDL	MA1016LKDL	MA1000e	MA1008e	MA1016e	MA 2600LKDL	MA3000
(+) (1)	25	36	6	5	11	12	15
(-) (2)	24	37	5	6	12	13	16
TRIGL (13)	-	E5	F3	F5 or F15	F5 or F15	F5	E5
INH0 (16)	-	-	-	21 (Zone 6)	32 (Zone 12)	-	-
TELCO IN (20)	RJ31X RED	RJ31X RED	RJ31X RED	RJ31X RED	RJ31X RED	RJ31X RED	RJ31X RED
TELCO (21)	RJ31X GRN	RJ31X GRN	RJ31X GRN	RJ31X GRN	RJ31X GRN	RJ31X GRN	RJ31X GRN
TELCO OUT (22)	19	31	24	25	40	40	35
TELCO OUT (23)	20	32	25	26	41	41	36
SENSE IN (24)	21	-	-	-	-	-	-
SENSE OUT (25)	RJ31X GY	-	-	-	-	-	-
Program Veri-Phone™	AUTO-SENSE	TRIG	TRIG	TRIG	TRIG	TRIG	TRIG

Table 3

Veri-Phone™ Terminal Strip Connections:

PIN NO.	DESCRIPTION
1	+ 12 Volts
2	Ground
3	Speaker (Ground)
4	Speaker (Hot)
5	Speaker/Speakermic Input
6	Microphone Number 1
7	Microphone Number 2
8	Microphone Number 3
9	Microphone Power +
10	Ground
11	Inhibit Control Input
12	Listen-Only Control Input
13	Trigger Input (Low)

PIN NO	DESCRIPTION
14	Trigger Input (High)
15	Control Output
16	Module-Active Output (INH0)
17	Normally-Open Relay Contact
18	Normally-Closed Relay Contact
19	Common Relay Contact
20	TELCO IN - TIP
21	TELCO IN - RING
22	TELCO OUT - TIP
23	TELCO OUT - RING
24	SENSE IN
25	SENSE OUT

Table 4

Glossary

Auto-Scan Auto-Scan causes the Veri-Phone™ to automatically scan the three microphone inputs in numeric order. Each microphone input is scanned for 5 seconds starting with microphone 1.

Automatic Callback Connect Mode With this method of central station operation, no CSAVM or additional equipment is needed. However, a separate phone line is required but no modification to the central station receiver is required. After an alarm condition is activated by the control panel and after the communicator has completed its call to central station, the Veri-Phone™ seizes the telephone line before the connection is lost. The Veri-Phone™ then goes into *One-Ring Ten-Minute Callback Mode*. This means that the Veri-Phone™ will allow the central station ten minutes to call back and will answer the call on the first ring. An Operator Access Code is programmable to further secure Veri-Phone™ communications.

Auto-Sense Method The Auto-Sense is an Veri-Phone™ activation method that is recommended when using a Napco 1008LKDL Control Panel or any Control Panel that does not have an output that changes state upon digital communications and then returns to a normal state upon kissoff. Wire for Voice or Alarm Priority.

Call-In Mode The User Call-In Mode is a feature designed to allow a user access to his Veri-Phone™ using TouchTone Commands. If enabling this feature, the User Access Code must be programmed. The default User Access Code is 1,2,3,4,5,6 and can be changed in User Programming.

CSAVM Operation The Central Station must be equipped with a CSAVM Two-Way Voice Interface for each incoming line to which the Veri-Phone™ will be connected. When the CSAVM is used with a standard receiver and a call is received from a control panel equipped with an Veri-Phone™, the CSAVM will then ring a standard phone, multiline keyset or PBX, informing the operator that a voice call is on the line.

Exclusive Microphone Selection If Exclusive Microphones is enabled and a command to turn on any microphone is made, all other microphones will be turned off. For example, turning on mic 1 will result in mics 2 and 3 turning off. **Note:** The operator will be able to turn on more than one mic at any given time by using the ALL MICS ON command followed by a MIC off command of the undesired microphone (if any).

Immediate Connect Mode With this method, the central station receiver must have Audio Verification capability. Set up the receiver so that the accounts to which the Veri-Phone™ will be connected will be in the Listen mode. Set the hold-time to a convenient time for the operator to pick up the phone that is connected to the same line as the receiver. When a call is received the central station line receiver will hold the line open until the operator picks up the phone.

One-Ring Ten-Minute Callback Mode The Veri-Phone™ on the premises will allow central station ten minutes to call back and will answer the call on the first ring.

Operator Access Code The Central Station Operator can only access the Veri-Phone™ with this code when the Veri-Phone™ is in the *One-Ring Ten-Minute Callback Mode*.

Restart Safety Timer When the Veri-Phone™ is accessed, a 4-minute timer starts. If there is no activity between the operator and premise, the Veri-Phone™ will automatically disconnect. The Restart Safety Timer (Command **7**) restarts the timeout period for an additional 4 minutes.

Safety Timeout After the Veri-Phone™ has been accessed and is in the Listen Mode, a 4-minute timer starts. If the Veri-Phone™ remains in the Listen Mode with no activity (no commands being accessed), it will sound two warning beeps 15 seconds prior to disconnecting.

Glossary (Continued)

Speakerphone Operation Similar to VOX operation, the Veri-Phone™ switches automatically between *Talk Mode* and *Listen Mode*. If a momentary short from INH (Terminal 11) to ground (Terminal 2) is applied while either a house phone is off hook or ringing, the Veri-Phone™ will go into Speakerphone operation. A subsequent momentary short to ground will cause a hangup.

Trigger Method The Trigger Method (Trigger Input Terminal 13) is the preferred method of Veri-Phone™ activation. This method can only be used with control panels that have an output that changes state upon digital communications and then return to a normal state upon kissoff.

User Access Code The User Call-In Mode is a feature designed to allow a user access to his Veri-Phone™ using the commands listed on page 22. If this feature is enabled, the User Access Code must be programmed. The default User Access Code is 1,2,3,4,5,6 and can be changed in User Programming. **Note:** The User Access Code is not changed to the default value unless the default program is accessed through Power Up Programming.

User Call-In Feature This programmable feature allows the customer to call into his premises at any time and establish two-way voice communication with the occupants. The user will dial his home phone number, and enter his user access code, prompting the Veri-Phone™ to seize the line. The user will then have access to TouchTone commands that will allow him to listen to and/or talk to the occupants. The subscriber can use this feature to check on the children, babysitter, elderly persons, etc., when away from home. When using this feature, it is recommended that the caller/listener obtain any required advance consent of the occupants of the premises prior to this procedure.

VOX Operation Voice Operated Switching. The Veri-Phone™ switches automatically between *Mode* and *Listen* mode. Pressing command **2** from the Standard or from Level 0 of the SIA command set allows the operator or user to talk and listen to the premises with out using the **1** and **3** keys. Separate speakers and microphones must be used for all VOX type communications.

INDEX

Access Code	
Operator Access Code	4, 13, 15
User Access Code	4, 19, 22
Activate with Listen or VOX Mode	
Programming	17
Auto-Scan	15, 32
SIA Command Set	25, 26
Standard Command Set	23, 24
Auto-Sense	5, 30
Alarm Priority	8, 14
Programming	17
Speakerphone Operation	14
Voice Priority	8, 14
Automatic Callback	
Programming	18
Testing	13
Callback	
Acknowledge on Callback	24
Automatic Callback Connect	4, 0, 13, 14, 18, 27-30
One-Ring Ten-Minute Callback Mode	4, 24, 27-29, 32
Operator Access Code	15, 18, 32
SIA Command Set	25, 26
Standard Command Set	23
Command Sets	
SIA Command Set	18, 19, 22, 23, 27
Standard Command Set	18, 19, 22, 23, 27
Control Output	14
SIA Command Set	25, 26
Specifications	31
Standard Command Set	23, 24
CSAVM	27, 28, 32
Automatic Callback Connect	28
Immediate Connect Method	28
Immediate Connect Operation	4
Ordering Information	31
Programming	17
Restart Safety Timer	24, 26
Dealer Programming	16-19
Dealer Programming Sheet	20, 21
Disable for Control Panel Downloading	16, 19
Exit Dealer Programming	16, 19
Local	16
Power-Up Programming	16
Remote	16
Default Program	16
User Access Code	16, 33
User Code	16
Download	
Control Panel	16, 19, 30
Exclusive Microphone	15, 32
Programming	17
Exclusive Microphone Selection	15
Programming	17
Immediate Connect Operation	4, 27, 29, 32
CSAVM Operation	27, 28
Testing	13
Inhibit Control	
Inhibit By Alarm	14
Speakerphone Operation	14
Inhibit Output	14
Listen Only Control	4, 14
Privacy	14

VERI-PHONE™ AUDIO VERIFICATION MODULE

MA1008e	9, 14, 31
MA1016e	9, 14, 31
Method of Veri-Phone™ Activation	5, 32
Alarm Priority Auto-Sense Method	8
Auto-Sense Method	5, 32
Programming	17
Trigger Method	5, 6, 33
Voice Priority Auto-Sense Method	8
Mic-30	10, 12
Microphones	10
Auto-Scan	15, 24, 26
Auto-Scan	15
Exclusive Microphone Selection	15
Mic-30	10
Microphone Gain Adjustments	12
Microphone Placement	12
Microphone Selection	12
Speakermics	11
State of Microphones at the beginning of Audio Verification	18
Two wire microphones	10
Module Active Output	14
Number Of Rings	19
Operator Access Code	15, 32
Programming	18
Operator VOX	
Programming	18
Power-Up Programming	16, 22
Safety Timer	23-26, 28, 32
SIA command set	15, 23, 25, 26
Operator	16
Programming	18
Siren Silencing	4, 9
MA1008e	9
MA1016e	9
Speaker	10
Speaker Gain Adjustment	12
Speaker Placement	12
Speaker Selection	12
Speakermic	10, 11
Speakerphone	11-14, 33
Standard Command Set	15, 23, 24
User	15, 27
State of Microphones at the beginning of Audio Verification	
Programming	18
Status Led	5, 12, 13
Trigger Method	5, 6, 17
Fast Trigger Method	7, 17
User Access Code	27, 32, 33
Programming	22
User Call-in	4, 14, 15, 19, 22, 27, 32, 33
Programming	19
Disabled	19
User Programming	
Local Programming	22
Remote Programming	22
Veri-Phone™ Activation	18
Programming	18
VOX	4, 33
Activate in Listen or VOX	17
Microphone and Speaker placement	12
Operator VOX	18
Speakermics	11
Status LED	5
VOX Talk/Listen Switching	13

NAPCO LIMITED WARRANTY

NAPCO SECURITY SYSTEMS, INC. (NAPCO) warrants its products to be free from manufacturing defects in materials and workmanship for thirty-six months following the date of manufacture. NAPCO will, within said period, at its option, repair or replace any product failing to operate correctly without charge to the original purchaser or user.

This warranty shall not apply to any equipment, or any part thereof, which has been repaired by others, improperly installed, improperly used, abused, altered, damaged, subjected to acts of God, or on which any serial numbers have been altered, defaced or removed. Seller will not be responsible for any dismantling or reinstallation charges.

In case of defect, contact the security professional who installed and maintains your security system. NAPCO shall have no obligation under this warranty, or otherwise, if the product has been repaired by others, improperly installed, improperly used, abused, altered, damaged, subjected to accident, nuisance, flood, fire or acts of God, or on which any serial numbers have been altered, defaced or removed. NAPCO will not be responsible for any dismantling, reassembly or reinstallation charges.

In order to exercise the warranty, the product must be returned by the security professional, shipping costs prepaid and insured to NAPCO. After repair or replacement, NAPCO assumes the cost of returning products under warranty.

There are no warranties, express or implied, which extend beyond the description on the face hereof. There is no express or implied warranty of merchantability or a warranty of fitness for a particular purpose. Additionally, this warranty is in lieu of all other obligations or liabilities on the part of NAPCO.

Any action for breach of warranty, including but not limited to any implied warranty of merchantability, must be brought within the six months following the end of the warranty period. In no case shall NAPCO be liable to anyone for any consequential or incidental damages for breach of this or any other warranty, express or implied, even if the loss or damage is caused by the seller's own negligence or fault.

This warranty contains the entire warranty. It is the sole warranty and any prior agreements or representations, whether oral or written, are either merged herein or are expressly cancelled. NAPCO neither assumes, nor authorizes any other person purporting to act on its behalf to modify, to change, or to assume for it, any other warranty or liability concerning its products.

In no event shall NAPCO be liable for an amount in

excess of NAPCO's original selling price of the product, for any loss or damage, whether direct, indirect, incidental, consequential, or otherwise arising out of any failure of the product. Seller's warranty, as hereinabove set forth, shall not be enlarged, diminished or affected by and no obligation or liability shall arise or grow out of Seller's rendering of technical advice or service in connection with Buyer's order of the goods furnished hereunder.

NAPCO RECOMMENDS THAT THE ENTIRE SYSTEM BE COMPLETELY TESTED WEEKLY.

Warning: Despite frequent testing, and due to, but not limited to, any or all of the following; criminal tampering, electrical or communications disruption, it is possible for the system to fail to perform as expected. NAPCO does not represent that the product/system may not be compromised or circumvented; or that the product or system will prevent any personal injury or property loss by burglary, robbery, fire or otherwise; nor that the product or system will in all cases provide adequate warning or protection. A properly installed and maintained alarm may only reduce risk of burglary, robbery, fire or otherwise but it is not insurance or a guarantee that these events will not occur. **CONSEQUENTLY, SELLER SHALL HAVE NO LIABILITY FOR ANY PERSONAL INJURY, PROPERTY DAMAGE, OR OTHER LOSS BASED ON A CLAIM THE PRODUCT FAILED TO GIVE WARNING.** Therefore, the installer should in turn advise the consumer to take any and all precautions for his or her safety including, but not limited to, fleeing the premises and calling police or fire department, in order to mitigate the possibilities of harm and/or damage.

NAPCO is not an insurer of either the property or safety of the user's family or employees, and limits its liability for any loss or damage including incidental or consequential damages to NAPCO's original selling price of the product regardless of the cause of such loss or damage. If the user wishes to protect itself to a greater extent, NAPCO will, at user's sole cost and expense, obtain an insurance policy to protect the user, supplemental to user's own policy, at a premium to be determined by NAPCO's insurer upon written notice from user by Certified Mail, Return Receipt Requested, to NAPCO's home office address, and upon payment of the annual premium cost by user.

Some states do not allow limitations on how long an implied Warranty lasts or do not allow the exclusion or limitation of incidental or consequential damages, or differentiate in their treatment of limitations of liability for ordinary or gross negligence, so the above limitations or exclusions may not apply to you. This Warranty gives you specific legal rights and you may also have other rights which vary from state to state.